

FAST TOUCH

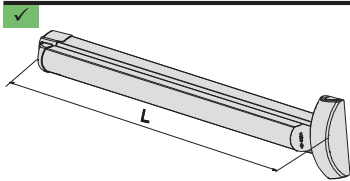

Antipánico de embutir giro de 30º de 1 punto.
En caso de puerta doble, si se quiere tener la pasiva también con antipánico, hay que contar con la sobrepuesta de 2 puntos.

Rojo-negro ✓

59711

Rojo- negro	F157315971101FR
-------------	-----------------

FAST PUSH

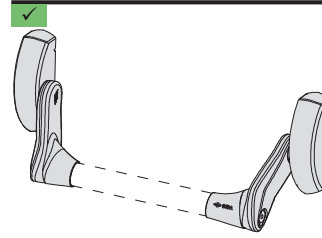

Antipánico de embutir de 1 punto lateral. Hace falta añadir la barra.
En caso de puerta doble, si se quiere tener la pasiva también con antipánico, hay que contar con la sobrepuesta de 2 puntos.

Rojo-negro ✓

59607

Accionadores negros	F157315960710FR
Barra roja de 840 mm	F1573107007130

SOLO GOLPE NUECA PARTIDA

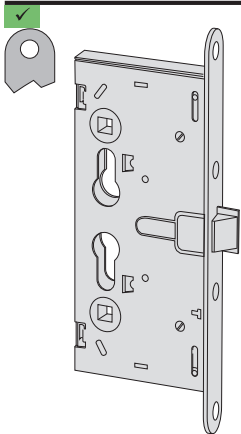

Cerradura antipánico, en el interior siempre actúa con el dispositivo antipánico o con la llave, en el exterior la llave condensa o descondensa la maneta y recoge la balda. La maneta exterior sólo recoge si está descondenada.

Plata ✓

43110.65

Plata	F157343110650
-------	---------------

G/. Y LLAVE NUECA PASANTE

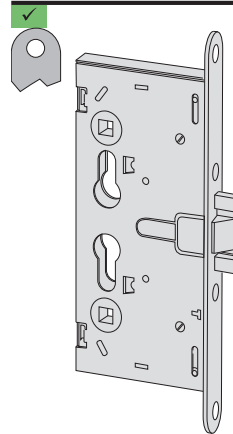

Cerradura antipánico, en el interior actúa con el dispositivo antipánico o la llave, en el exterior la llave retrae picaporte y la palanca.

Plata ✓

43120.65

Plata	F157343120650
-------	---------------

SERIE UNIVERSAL



Antipánico para cerradura encastrada. Barra de 900 mm. Nueca de 8 mm.

Negro - verde ✓
Satinado - cromado ✓

1970

Negro - Verde	F1525197098NV
Satinado - cromado	F1525197098SC

FAST TOUCH

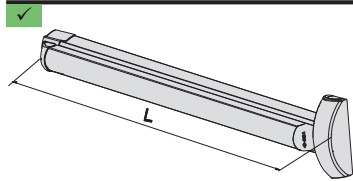

Antipánico de sobreponer de 1 punto.

Rojo-negro ✓

59801

Rojo- negro	F1573159501110
-------------	----------------

FAST PUSH

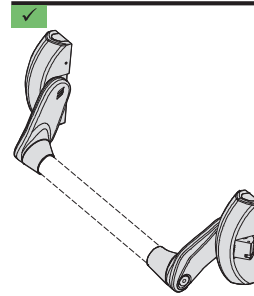

Antipánico de sobreponer de 1 punto lateral. Hace falta añadir la barra.

Rojo-negro ✓

59816

Accionadores negros	F1573159001100
Barra roja de 840 mm	F1573107007130

FAST TOUCH

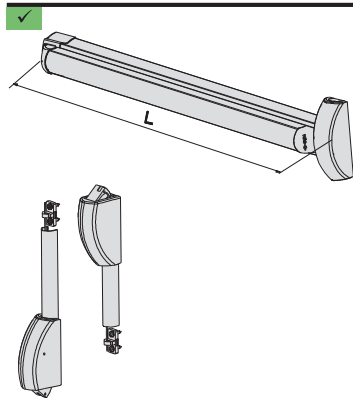

Antipánico de sobreponer de 2 puntos. Hay que añadir los cierres superior e inferior.

Rojo-negro ✓

59816

Rojo- negro	F1573159816110
Sup+inf (1240+1000)	F1573107063610

FAST PUSH

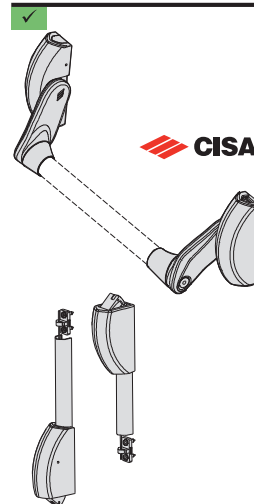

Antipánico de sobreponer de 2 puntos lateral. Hace falta añadir la barra y los cierres superior e inferior.

Rojo-negro ✓

59016

Accionadores negros	F1573159016100
Barra roja de 840 mm	F1573107007130
Sup+inf (1240+1000)	F1573107063610

MANILLAS EXTERIORES

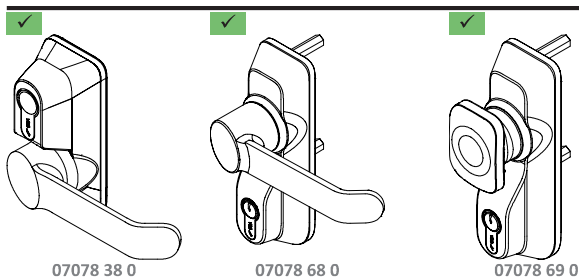

Solo válidas para cerraduras de sobreponer. La llave condena las manetas y el pomo.

Negro ✓

MANILLAS EXTERIORES

07078 38 0	F1573107078380
07078 68 0	F1573107078680
07078 69 0	F1573107078690

SERIE UNIVERSAL

TESA

✓

Antipánico de sobreponer de 1 punto lateral. Incluye barra de 900 mm.

Puerta de una hoja

Puerta de dos hojas

CON SOLAPA

Negro - verde ✓

1910

Negro - Verde	F1525191098NV
---------------	---------------

SERIE UNIVERSAL

TESA

✓

Antipánico de sobreponer de 2 puntos sup e inf. Incluye barra horizontal de 900 mm y 2 verticales de 930 mm.

Puerta de una hoja

Puerta de dos hojas

CON SOLAPA

SIN SOLAPA

Negro - verde ✓

1930

Negro - Verde	F1525193098NV
---------------	---------------

SERIE UNIVERSAL

TESA

✓

Antipánico de sobreponer de 3 puntos central, sup e inf. Incluye barra horizontal de 900 mm y 2 verticales de 930 mm.

Puerta de una hoja

Puerta de dos hojas

CON SOLAPA

SIN SOLAPA

Negro - verde ✓

1950

Negro - Verde	F1525195098NV
---------------	---------------

IN.20.789



Cerradura antipánico, cuando actua la maneta recoge el golpe y el pestillo. Cuando la puerta se cierra, golpe y pestillo cierran automáticamente.

Ac. Inoxidable 

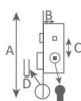

0515

Ax55x65xD	
Ac. Inoxidable	F106320789

CUADRADILLOS DOBLES

TESA

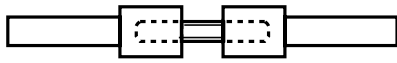

Zincado

CUADRADILLOS

8/8 + 8/8	F1525CD2030S8
8/9 + 9/8	F1525CD60MAK
9/9 + 9/8	F1525CDCF6089
Reductor 9 a 8	F1525CASF50

43020



Cerradura cortafuego golpe y llave.

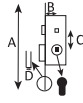

Plata

43020

(A)x(B)x(C)x(D)	
235x65x72x24 mm	F1573430200650

2030F



Colegios, hospitales, oficinas... soportan un tráfico elevado de personas y una utilización intensiva. Los herrajes para edificios institucionales de la gama Institucional conjugan altas prestaciones con funcionalidad, y se combinan perfectamente con el resto del catálogo de TESA: manillas, barras antipánico, dispositivos electromagnéticos, etc. Las cerraduras 2030F de la gama Institucional están certificadas según la norma UNE-EN 12209. Certificado CE.



Plata
Latonado

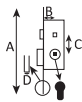

2030F

240x(B)x85x23	Nueca pasante		Nueca partida	
	con cilindro	Sin cilindro	Derecha (con cil)	Izquierda (sin cil)
Inox B=50 Recto	F15252030F5AI		F15252030F5DI	F15252030F5II
Inox B=50 Redondo	F15252030F5RAI	F152540305RD		
Inox B=60 Recto	F15252030F6AI			
Dorado B=50	F15252030F5HL			

4401



Placas con manilla para puerta cortafuego.

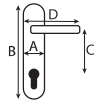

Negro

4401

(A)x(B)x(C)x(D)	
AxBxD	F20404401

4400



Placas con manilla para puerta cortafuego.

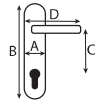

Negro

4400

(A)x(B)x(C)x(D)	
AxBx72xD	F20404400

4403



Placas con pomo fijo para puerta cortafuego.

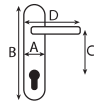

Negro

4403

(A)x(B)x(C)x(D)	
AxBxD	F20404403

4402



Placas con pomo fijo para puerta cortafuego.

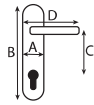

Negro

4402

(A)x(B)x(C)x(D)	
AxBx72xD	F20404402

070070 14

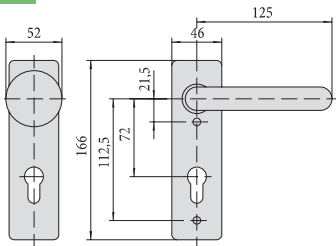

Placas con bocallave. Pomo y manilla.

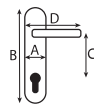

Negro

070070 14

(A)x(B)x(C)x(D)	
46x166x72x148 mm	F157307070140

070070 12

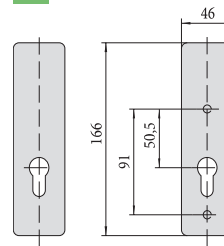

Placas con bocallave.

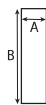

Negro

070070 12

(A)x(B)	
46x166 mm	F157307070120

070070 16

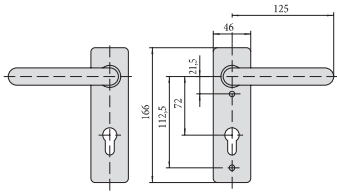

Placas con manilla para puerta corta-fuego.

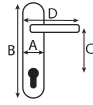

Negro

070070 16

(A)x(B)x(C)x(D)	
46x166x72x148 mm	F157307070160

070070 15

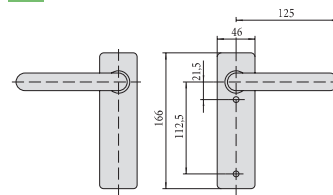

Placas con manilla para puerta corta-fuego.

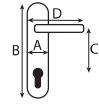

Negro

070070 15

(A)x(B)x(C)x(D)	
46x166xCx148 mm	F157307070150